Coolant Pump

Model : VKB-e

 **WARNING**

Do not operate, service or inspect this pump until you have read and understood this manual.

Keep this manual in a safe place where it can be consulted at any time.

To : All mechanical Contractor

Make sure to supply copies of this manual to the customer's operator maintenance and inspection personnel.

Limited warranties

1. In the event of a failure or breakage under proper use of the product during the warranty period, equipment supplied by TERAL INC. shall be repaired or replaced free of charge within the scope of the relevant part, provided that such failure or breakage is attributable to inadequacy of the design or workmanship of the equipment.
The warranty period of this product shall be one year after the date of delivery.
2. The warranty mentioned in the above clause shall be only the mechanical warranty of the defective part, and shall not cover any expenses or other damage arising from the failure or breakage.
3. In the event of the following failures and breakage, the costs of the repairs shall be borne by the user.
 - (1) Failures and breakage attributable to equipment that was not delivered by TERAL INC.
 - (2) Failures and breakage after the expiration of the warranty period
 - (3) Failures and breakage caused by disasters or force majeure, such as fire, acts of God, or earthquakes
 - (4) Failures and breakage resulting from repairs or modifications made without the consent of TERAL INC.
 - (5) Failures and breakage when parts other than those designated by TERAL INC. are used
 - (6) Failures and breakage caused by use or storage outside the specification range
4. TERAL INC. shall not be liable for the damage caused by incorrect or reckless use of the pump. Cost and expenses incurred for sending engineer(s) in such a case shall be borne by the user.
5. If the cause of the failure is unclear, necessary actions shall be determined through mutual consultation.

<Paid repairs>

After the expiration of the warranty period, the costs of investigation and repairs related to the product shall be borne by the user. For any failures that have occurred within the warranty period but that fall outside the above-mentioned warranty coverage, TERAL INC. shall carry out repairs and investigation for a fee. Please give us the instructions to do so in such a case.

Purpose of this manual

The purpose of this manual is to provide the user with detailed information necessary to properly operate, maintain and inspect the pump. Incorrect operation of this product may lead to an unexpected accident.

Please use the product correctly according to this instruction manual.

This manual contains the following information and is intended for persons experienced in the operation of pumps, or for those who have been trained by such experienced operators. Only qualified personnel such as licensed electrical engineers are allowed to carry out the electrical wiring work.

Contents

	(Page)
Limited warranties	I
Purpose of this manual	II
Contents	II
1. Safety precautions.....	1-1
1.1 Types and meanings of warning terms and graphic symbols	1-1
1.2 Safety precautions.....	1-1
1.3 Location of warning labels and caution labels.....	1-4
2. Configuration and overview of the pump.....	1-4
2.1 Part names and functions.....	2-1
2.2 Naming rule of the model codes.....	2-1
2.3 Standard specifications	2-2
2.4 Information indicated on the nameplates	2-3
2.5 Specification table	2-4
2.6 Dimensional outline drawing and dimensions table	2-5
2.7 Internal structure drawing.....	2-10
3. Transportation, movement, storage and installation	3-1
3.1 Precautions for transporting, moving and storing the pump	3-1
3.2 Before using the pump	3-1
3.3 Precautions for installation	3-2
3.4 Precautions for piping work.....	3-4
3.5 Precautions for wiring work	3-5
4. Operation.....	4-1
4.1 Check items before test operation.....	4-1
4.1.1 Check items related to the electrical system	4-1
4.1.2 Check items related to the pump	4-1
4.2 Running the pump (test operation).....	4-2
5. Maintenance and inspection.....	5-1
5.1 Precautions for maintenance and inspection	5-1
5.2 Daily inspection	5-2
5.3 Periodic inspection	5-3
6. Troubleshooting.....	6-1
7. After-sales service.....	7-1
8. Disposal.....	8-1
8.1 Precautions for disposal	8-1

1. Safety precautions

1.1 Types and meanings of warning terms and graphic symbols

This instruction manual divides precautions into the following four categories according to the level of hazards (or the severity of the accident). In addition, prohibited or mandatory actions as well as cautions are indicated with a graphic symbol.

Be sure to understand the meanings of the following terms and comply with the content (instructions) of the instruction manual.

■ Explanation of the warning terms

Warning Term	Meaning
Danger	Indicates an imminently hazardous situation. Failure to observe this will result in death or serious injury.
Warning	Indicates a potentially hazardous situation. Failure to observe this will result in death or serious injury.
Caution	Indicates a potentially hazardous situation. Failure to observe this will result in minor or moderate injury or property damage.
Note	Indicates information that is in particular to be noted or emphasized.





























■ Explanation of the graphic symbols











Don'ts Do not touch Do not disassemble Do not touch with wet hand Do not expose to water
These graphic symbols indicate prohibited actions (that must NOT be done).
Do's <p>This graphic symbol indicates mandatory actions (that must be done).</p>
Caution Electric shock hazard Rotation hazard Hot surface
These graphic symbols indicate existing hazards to beware of.

1.2 Safety precautions



























Danger	
	<p>Once the main power is turned on, do not touch any live parts. A high voltage applied to live parts may cause a serious electric shock, thus leading to death.</p>
	<p>Do not use the product in any explosive atmosphere. Otherwise, it may lead to an injury or fire.</p>

Warning	
<p>Properly move the unit according to hoisting instructions. Otherwise, the unit may fall, thus leading to an injury or damage.</p>	<p>Do not carry out any work with/on the pump that is being hoisted. Otherwise, the unit may fall, thus leading to an injury or damage.</p>
<p>Only those who are authorized by the site manager are allowed to operate the pump. Operation by unskilled personnel may lead to an unforeseen accident.</p>	<p>Installation, maintenance, and inspection must only be carried out by personnel who have been trained to handle the pump. Operation by unskilled personnel may lead to an unforeseen accident.</p>
<p>Only qualified personnel, such as licensed electrical engineers, are allowed to carry out electric work. Otherwise, it may lead to an electric shock, fire, failure, or other problems.</p>	<p>Use high-quality wiring equipment and devices, and carry out wiring work safely and securely in accordance with applicable electrical equipment technical standards and interior wiring code. Otherwise, it may lead to an electric shock, fire, or other problems.</p>
<p>Do not connect the ground wire to a gas pipe or water pipe. Such a connection is illegal and leads to an electric shock, explosion, or fire.</p>	<p>Securely install the ground wire and ensure to carry out grounding work. Otherwise, it may lead to an electric leak or electric shock.</p>
<p>Do not run the unit if abnormal condition is observed in any operation, movement, parts, etc. Otherwise, it may lead to an injury, failure, or various accidents.</p>	<p>Correctly and securely connect the wires according to the wiring diagram within the terminal box and the instruction manual. Incorrect wiring may cause a fire, electric shock, failure, or other problems.</p>

 Warning	
<p> Be sure to keep the terminal box cover attached during the operation of the pump. Otherwise, it may lead to an electric shock.</p> <p></p>	<p> Be sure to install the coupling guard during the operation of the pump. Otherwise, it may lead to an injury or damage.</p> <p></p>
<p> After detaching the companion flange from the pump, screw a pipe into it. Otherwise, it may lead to damage or leakage.</p>	<p> Do not forcibly bend, pull, or pinch the power cable or any lead wires of the product.</p> <p> Otherwise, it may lead to an electric shock or fire.</p>
<p> Check the wiring sections and wires for any looseness. A loose connection may cause a fire or electric shock.</p> <p></p>	<p> Before starting the maintenance or inspection work, be sure to stop the pump and turn off the main power of the panel board. Otherwise, it may lead to an electric shock, injury, damage, or leakage.</p> <p></p>
<p> Before starting the unit or carrying out maintenance/inspection work, ensure that all the relevant workers are informed of the operation and that there are no workers in the dangerous zone. Otherwise, it may lead to an unforeseen accident.</p>	<p> Before rotating the main shaft by hand to check its smooth rotation, be sure to turn off the main power. Otherwise, it may lead to an injury or damage.</p> <p></p>
<p> After turning on the power, do not touch any parts of the pump other than those required for operation. Otherwise, it may lead to an electric shock or injury.</p> <p></p>	<p> Do not perform long hours of zero-discharge operation continuously. Otherwise, the temperature and pressure may increase inside the pump, thus damaging the pump or causing steam to blow off.</p> <p></p>
<p> Do not put your fingers or foreign objects into any openings or rotating part of the motor during operation. Otherwise, it may lead to an injury or damage.</p> <p></p>	<p> For overhaul, replacement of parts, or repairs, ask TERAL INC.</p> <p> If unskilled personnel carry out work that requires special knowledge, it may lead to an accident or failure.</p>
<p> In the event of a power failure, be sure to turn off the power switch. Otherwise, the pump may suddenly start up on restoration of the power, thus leading to an injury.</p>	<p> Electric motor or control panel insulation degradation may result in electric leakage, electric shock, or fire.</p> <p> Keep the ambient temperature at 0 to 40°C with sufficient ventilation to prevent damage to the equipment and deterioration of its life.</p> <p>Avoid dust, corrosive or explosive gases, salinity, humidity, condensation. For indoor installations avoid direct sunlight or wind and rain.</p>
<p> Regularly inspect your equipment and perform maintenance on each component.</p>	<p> If motors or control panels are used for more than a certain period of time, it may cause ignition or other accidents due to aging deterioration.</p>



 Caution	
<p> Do not use the unit outside the range of the product specifications. Otherwise, it may lead to an electric shock, fire, leakage, failure, or other problems.</p> <p></p>	<p> Do not use the unit at an incorrect power voltage. An incorrect voltage may damage the motor.</p>
<p> Do not use a single pump unit as the only means of directly operating key facilities or sustaining life. In the event of a failure, the water supply may stop. Ensure to make a backup unit available for operation.</p>	<p> Before unpacking the delivered container, check that the container is placed in the correct orientation (not upside down). Carefully unpack the container, while paying special attention to nails. Otherwise, it may lead to an injury or damage.</p>
<p> Ensure that the floor at the unit's installation place is waterproofed and fitted with drainage. Otherwise, it may lead to serious damage in the event of leakage.</p>	<p> Do not install two or more different cables or control wires in one pipe or duct. Otherwise, it may lead to malfunction of the product or other equipment.</p>
<p> Do not step on the pump or motor. Otherwise, it may lead to an injury, damage, or other problems.</p>	<p> Do not expose the motor to water. Otherwise, it may lead to an electric shock, electric leak, failure, or other problems.</p> <p></p>

 **Caution**

<p> Operate the controls carefully. Otherwise, it may lead to an injury or damage.</p>	<p> During test operation, never run the pump dry (i.e. never run the pump when the liquid level is below the Minimum liquid level). Otherwise, it may lead to damage or a fire.</p>
<p> Before operation, thoroughly clean (flush) the inside of the piping to remove foreign matter. Otherwise, the piping system may be contaminated with foreign matter, thus leading to an accident or a pump failure.</p>	<p> During normal operation, do not run the pump dry for more than 30 seconds. Otherwise, it may lead to damage or a fire.</p>
<p> Do not put a cloth or other covering on the motor. Otherwise, it may lead to overheating or ignition.</p>	<p>  Do not touch the motor body while the pump is running or immediately after the pump has stopped. Otherwise, you may get burns from the hot surface.</p>
<p> In the event of an alarm or abnormal condition that cannot be resolved, immediately stop the operation, turn off the power, and then contact TERAL INC. Otherwise, it may lead to an accident.</p>	<p> Do not run the pump with tools or other objects placed on the unit. Otherwise, it may lead to an injury or damage.</p>
<p> Check that the delivered items are exactly what you ordered. The use of a wrong product may cause an injury or failure.</p>	<p> Do not hold the strainer located on the tip of the pump. Otherwise, the strainer may come off, thus leading to an injury or damage.</p>
<p> Do not place any obstacles around the product that may hinder ventilation. Otherwise, it may lead to a fire.</p>	<p> Do not place any combustibles around the product. Otherwise, it may lead to a fire.</p>
<p> Do not run the pump at a frequency exceeding 60 Hz (50 Hz for models dedicated to 50Hz). Otherwise, it may lead to motor burnout or a fire.</p>	<p> Do not touch the impeller, tie bolt, strainer, screw, or other parts of the pump with bare hands. Otherwise, it may lead to an injury or damage.</p>
<p> Ensure to install an overcurrent protective device. The user is required by the technical standards for electrical facilities to install one. Otherwise, it may damage the product, thus leading to a fire or failure. It is also recommended to install protective devices such as a ground fault interrupter.</p>	<p> Do not use the unit for pumping any fluids beyond the specified viscosity limit. Otherwise, it may lead to motor burnout or a fire.</p>
<p> Do not run the pump with its strainer removed. Otherwise, it may lead to an injury or damage.</p>	<p> Do not touch any terminals or wires when measuring the insulation resistance. Otherwise, it may lead to an electric shock.</p>
<p> Do not touch the screw after removing the strainer. Otherwise, it may lead to an injury.</p>	<p> Once you turn off the power, wait until the pump stops completely. Do not restart the pump until it does. Otherwise, the main shaft may be subjected to an excessive load, which makes the service life of the pump shorter.</p>
<p> Do not use thinner or benzine for cleaning the product. Otherwise, the product may be discolored or its coating may be peeled off.</p>	<p> If you use a solvent for cleaning the product, pay attention to handling of the solvent as well as the environment of use. Otherwise, it may lead to poisoning.</p>
<p> When you hoist the product, pay attention to its center of gravity. Otherwise, the product may topple over or fall, thus leading to an injury.</p>	<p> Dispose of the product as industrial waste.</p>
<p> Be sure to conduct inspection according to the Maintenance checklist. Otherwise, you cannot prevent potential failures, thus leading to a higher risk of accidents.</p>	<p> When you lift the product by hand, pay attention to its weight. Do not allow a single person to lift a product heavier than 15 kg. Otherwise, it may put strain on the body, thus leading to an injury.</p>

1.3 Location of warning labels and caution labels

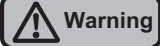
The figure shows the locations of warning labels and caution labels. If these labels become dirty and illegible or if they are peeled off, replace them with a new one.



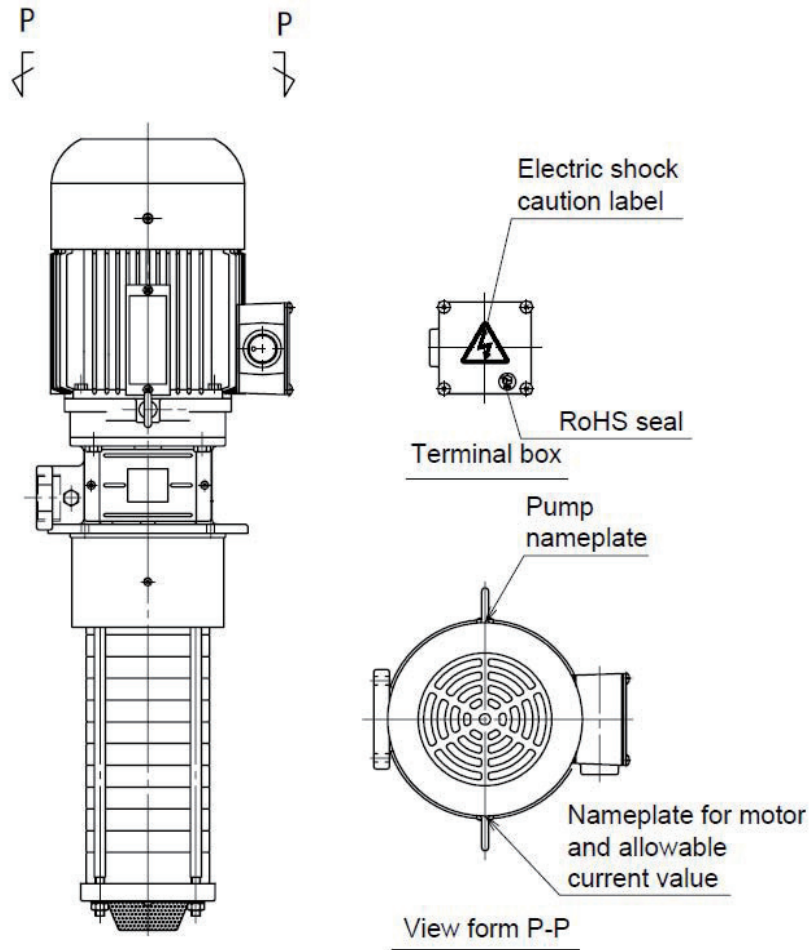

 **Warning**  **Caution** 

Observe all the instructions in the warnings and cautions affixed to the machine as well as those described in this instruction manual.



2. Configuration and overview of the pump

This chapter describes the standard specifications of the pump. For details, refer to the delivery specifications such as the dimensional outline drawing and the internal structure drawing. If you have purchased a customized product, some information in this chapter may not be applicable to your unit. See the dimensional outline drawing, the internal structure drawing, and other documents to check the product specifications in such a case.

 **Caution**



Do not use this product under any conditions other than those provided in the specifications. Otherwise, it may lead to an electric shock, fire, leakage, or failure.





2.1 Part names and functions

- ① Motor
- ② Discharge port
- ③ Suction port (with strainer)
- ④ Air vent valve

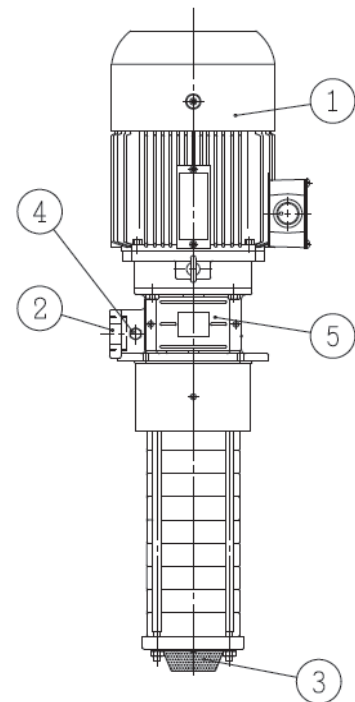
If air cannot be released from the pump to the atmosphere on the discharge piping, you can discharge air using this valve to prevent dry running.

- ⑤ Coupling guard



 **Warning**
 **Caution**



Be sure to keep the coupling guard and the strainer attached during the operation of the pump. Otherwise, it may lead to an injury.

2.2 Naming rule of the model codes

V K B 1 2 1 5 2 A Q - e
 ① ② ③ ④ ⑤ ⑥ ⑦

- | | |
|---|---|
| <ul style="list-style-type: none"> ① Model ② Number of impellers (5 to 26) ③ Number of casing stages (10 to 26) ④ Series number | <ul style="list-style-type: none"> ⑤ Phase and frequency
(A: 3-phase 50Hz/60Hz, F: 3-phase 50Hz only) ⑥ Characteristics
(H: Pressure type, Q: Flow rate type) ⑦ With a built-in top runner efficiency (IE3-equivalent) motor |
|---|---|

2.3 Standard specifications*

Applicable liquid	Quality	Grinding fluid, cutting fluid, etc. after secondary treatment ^{Note 1}	
	Temperature	-20 to 90°C (No frozen liquid is allowed.)	
	Dynamic viscosity	See "Note 2."	
Installation location		Indoors; height above sea level: 1,000 m or less; ambient temperature: -20 to 40°C; humidity: less than 85%RH (no condensing); place not exposed to direct sunlight; place without any corrosive gas, explosive gas, or vapor in the atmosphere	
Bore [Rp]		1 1/4	
Material	Pump leg	FC200	
	Casing, outer cylinder	SUS304	
	Suction cover	FC150	
	Impeller	SUS304	
	Main shaft (motor / pump)	S35C/SUS316	
Shaft sealing structure		Sealless structure (without mechanical seal)	
Motor	Type	Totally-enclosed fan-cooled indoor type	
	IP protection	IP54	
	Power ^{Note 3}	A: 3-phase 50/60Hz	200/200-220V
		F: 3-phase 50Hz	200V
	Insulation class	Class F	
	Number of poles	2P	
Standard		IEC60034-1	
Noise [dB(A)]		71	
Coating color	Pump	Munsell N1	
	Motor	- Body & outer fan cover: Melamine-baked, Munsell N1 (gloss) - Terminal box: Cationic coating	

Note 1 Under the conditions that contain hard sludge—such as abrasive powders, grinding powders, and diamond abrasive grains—in the pumping fluid, the service life of the product may become shorter. In such a case, install a filter (e.g. magnet filter or paper filter). Note that the product cannot be used for water or special liquids such as printing liquids or acidic liquids. For other special liquids (e.g. pure water, alkaline/acidic liquids, and ceramic liquids), contact TERAL INC.

Note 2 If you pump liquids with a dynamic viscosity beyond the limit specified in the following table, the service life of the motor may become shorter, thus leading to motor burnout. Be sure to use a liquid with a dynamic viscosity below the limit specified in the following table. Note that a decrease in liquid temperature could significantly increase its dynamic viscosity. Before pumping a liquid, check its dynamic viscosity at the minimum liquid temperature. The characteristics of the pump deteriorate as an increase in the dynamic viscosity of the liquid.

Model	Maximum allowable limit of dynamic viscosity for liquids to be pumped [mm ² /s]	
	Running at 50Hz	Running at 60Hz
VKB07□□2AH-e, VKB04□□2AQ-e VKB06□□2AQ-e, VKB12□□2AQ-e	75	37.5
VKB□□□□2F□-e (50Hz dedicated models)	1 (*)	1 (*)
Any other models	75	75

(*) The 50Hz dedicated models can only be used for liquids with a dynamic viscosity of 1 mm²/s or lower (exclusively for water-soluble coolant). If you need to pump liquids with a dynamic viscosity of over 1 mm²/s (oil-based coolant), consult TERAL INC..

Note 3 Limit the fluctuations of the power voltage within ±10% of the rated voltage, and also limit the fluctuations of the frequency between -5% and +3% of the rated value. Avoid continuous operation if the voltage is not within ±5% of the rated value or if the frequency is not within ±2% of the rated value.



* This product is labeled with a self-declaration CE mark and complies with the Essential Safety Requirements (ESRs) of the “EU (EC) Directive.” The following are the general descriptions.

Manufacturer	TERAL INC. 230 Moriwake, Miyuki-cho, Fukuyama-city, Hiroshima 720-0003 Japan
Product	VKB-e model coolant pump
Standards	Machinery Directive 2006/42/EC
	EN 809/A1:2009, EN ISO 12100:2010, EN 60204-1:2018
Manufacturer (Japan)	TERAL.INC., Hiroshima
Administrator (EU nations)	Shiran Tower 5F Luzna 716/2 160 00 Vokovice, Praha 6 CZECH REPUBLIC Person in charge: Tomohisa Yamamoto
Place of declaration	Hiroshima, Japan Manager: Taiji Monden

2.4 Information indicated on the nameplates

The pump nameplate (for indicating the pump specifications) and the motor nameplate (for indicating the motor specifications) are affixed to the product. Upon receiving the pump, check the pump nameplate to verify that the delivered product is exactly what you ordered. Be sure to confirm the model, nominal output, frequency, and voltage. The following figure and table show the appearance of the pump nameplate and the information indicated on it.

If by any chance you find anything wrong, contact the vendor from which you purchased the product. Do not place any obstacles in front of the nameplate or remove it. Always keep the nameplate clearly visible.

Do not run the pump at a frequency exceeding 60 Hz (50 Hz for models dedicated to 50Hz). Otherwise, it may lead to overload and burnout of the motor.

TERAL		COOLANT PUMP		CE	
3-PHASE a. c. INDUCTION MOTOR					
TYPE	①	Hz	⑥		
OUTPUT	②	kW	VOLT	⑦	
PIPE SIZE	③	B	AMP	⑧	
HEAD	④	m	min ⁻¹	⑨	
Q' TY	⑤	L/min	Maximum safe operating speed	⑩	
Year of manufacture	⑪		BRG	D-END	⑬
Main document NO.	⑫		N-END	⑭	
SER NO.	⑮				
230, Moriwake, Miyuki-cho, Fukuyama-city, Hiroshima, 720-0003, Japan			TERAL INC.		M-0021--

Pump nameplate

No.	Item
1	Model
2	Nominal output (kW) ^{*1}
3	Discharge bore (B)
4	Total head (m)
5	Discharge rate (L/min)
6	Frequency (Hz)
7	Voltage (V)
8	Current (A) ^{*2}
9	Rotating speed (min ⁻¹)
10	Max. allowable rotating speed (min ⁻¹)
11	Year of manufacture
12	Instruction manual No.
13	Inboard bearing type
14	Outboard bearing type
15	Serial number

*1 The output indicated on the pump nameplate is nominal output and may differ from the rated output of the motor. The nominal output is an approximate output value when the pump runs at the specified point and at a dynamic viscosity of 1 mm²/s.

*2 The electric current indicated on the pump nameplate may differ from the rated current of the motor. The electric current indicated on the pump nameplate is based on actual use. TERAL INC. recommends using this value as the setup current value of its protective device.

2.5 Specification table

• Models VKB-AH-e

Model	VKB05□□2AH-e		VKB06□□2AH-e		VKB07□□2AH-e		VKB08□□2AH-e		VKB09□□2AH-e		VKB10□□2AH-e		VKB11□□2AH-e		VKB12□□2AH-e	
Specifications																
Nominal output (kW)	0.5	0.85	0.6	1.02	0.7	1.19	0.8	1.36	0.9	1.53	1.0	1.7	1.1	1.87	1.2	2.04
Rated voltage (V)	200	200 220	200	200 220	200	200 220	200	200 220	200	200 220	200	200 220	200	200 220	200	200 220
Frequency (Hz)	50	60	50	60	50	60	50	60	50	60	50	60	50	60	50	60
Rated electric current (A)	5.4	5.8 5.6	5.9	6.0 5.8	6.2	6.0 5.8	6.9	8.8 8.3	7.4	10.0 9.1	12.0	10.3 10.6	12.3	11.1 11.3	12.5	11.7 11.8
Starting electric current (A)	56.0	55.0 60.0	56.0	55.0 60.0	56.0	55.0 60.0	84.0	73.0 80.0	84.0	73.0 80.0	180	152 167	180	152 167	180	152 167
Discharge rate (L/min)	40	50 60.0	40	50 60.0	40	50 60.0	40	50 80.0	40	50 80.0	40	50 106	40	50 113	40	50 118
Total head (m)	30	40	36	48	42	56	48	64	54	72	60	80	66	88	72	96
Maximum allowable limit of dynamic viscosity [mm ² /s]	75	75	75	75	75	75	75	75	75	75	75	75	75	75	75	75

Model	VKB13□□2AH-e		VKB14□□2AH-e		VKB15□□2AH-e		VKB16□□2AH-e		VKB17□□2AH-e		VKB18□□2AH-e		VKB19□□2AH-e	
Specifications														
Nominal output (kW)	1.3	2.21	1.4	2.38	1.5	2.55	1.6	2.72	1.7	2.89	1.8	3.06	1.9	3.23
Rated voltage (V)	200	200 220	200	200 220	200	200 220	200	200 220	200	200 220	200	200 220	200	200 220
Frequency (Hz)	50	60	50	60	50	60	50	60	50	60	50	60	50	60
Rated electric current (A)	12.9	12.7 12.6	13.1	13.5 13.2	13.6	14.4 13.9	14.0	15.3 14.6	14.5	16.2 15.3	15.2	16.2 15.3	15.7	16.2 15.3
Starting electric current (A)	180	152 167	180	152 167	180	152 167	180	152 167	180	152 167	180	152 167	180	152 167
Discharge rate (L/min)	40	50 60	40	50 60	40	50 60	40	50 80	40	50 80	40	50 106	40	50 113
Total head (m)	78	104	84	112	90	120	96	128	102	136	108	144	114	152
Maximum allowable limit of dynamic viscosity [mm ² /s]	75	75	75	75	75	75	75	75	75	75	75	75	75	75

Note 1) The rated electric current in the above table (current value indicated on the pump nameplate) is the recommended preset current value of the protective device.

• Models VKB-FH-e (50Hz dedicated models)

Model	VKB05□□2FH-e		VKB06□□2FH-e		VKB07□□2FH-e		VKB08□□2FH-e		VKB09□□2FH-e		VKB10□□2FH-e		VKB11□□2FH-e		VKB12□□2FH-e		VKB13□□2FH-e		VKB14□□2FH-e		VKB15□□2FH-e	
Specifications																						
Nominal output (kW)	0.5	0.6	0.7	0.8	0.9	1.0	1.1	1.2	1.3	1.4	1.5	1.6	1.7	1.8	1.9	2.0	2.1	2.2	2.3	2.4	2.5	2.6
Rated voltage (V)	200	200	200	200	200	200	200	200	200	200	200	200	200	200	200	200	200	200	200	200	200	200
Rated electric current (A)	3.6	4.0	4.4	5.8	6.3	6.4	6.9	7.2	7.6	8.0	8.5	9.0	9.4	10.0	10.5	11.3	12.9	13.6	14.1	14.5	14.9	15.4
Starting electric current (A)	30.0	30.0	30.0	56.0	56.0	56.0	84.0	84.0	84.0	84.0	84.0	84.0	84.0	84.0	84.0	84.0	180	180	180	180	180	180
Discharge rate (L/min)	40	40	40	40	40	40	40	40	40	40	40	40	40	40	40	40	40	40	40	40	40	40
Total head (m)	30	36	42	48	54	60	66	72	78	84	90	96	102	108	114	120	126	132	138	144	150	156
Maximum allowable limit of dynamic viscosity [mm ² /s]	1	1	1	1	1	1	1	1	1	1	1	1	1	1	1	1	1	1	1	1	1	1

Model	VKB16□□2FH-e		VKB17□□2FH-e		VKB18□□2FH-e		VKB19□□2FH-e		VKB20□□2FH-e		VKB21□□2FH-e		VKB22□□2FH-e		VKB23□□2FH-e		VKB24□□2FH-e		VKB25□□2FH-e		VKB26□□2FH-e	
Specifications																						
Nominal output (kW)	1.6	1.7	1.8	1.9	2.0	2.1	2.2	2.3	2.4	2.5	2.6	2.7	2.8	2.9	3.0	3.1	3.2	3.3	3.4	3.5	3.6	3.7
Rated voltage (V)	200	200	200	200	200	200	200	200	200	200	200	200	200	200	200	200	200	200	200	200	200	200
Rated electric current (A)	9.0	9.4	10.0	10.5	11.3	12.9	13.6	14.1	14.5	14.9	15.4	16.2	16.7	17.2	17.7	18.2	18.7	19.2	19.7	20.2	20.7	21.2
Starting electric current (A)	84.0	84.0	84.0	84.0	180	180	180	180	180	180	180	180	180	180	180	180	180	180	180	180	180	180
Discharge rate (L/min)	40	40	40	40	40	40	40	40	40	40	40	40	40	40	40	40	40	40	40	40	40	40
Total head (m)	96	102	108	114	120	126	132	138	144	150	156	162	168	174	180	186	192	198	204	210	216	222
Maximum allowable limit of dynamic viscosity [mm ² /s]	1	1	1	1	1	1	1	1	1	1	1	1	1	1	1	1	1	1	1	1	1	1

Note 1) The 50Hz dedicated models can be used exclusively for water-soluble coolant (dynamic viscosity: up to 1 mm²/s). If you need to pump oil-based coolant, consult us.

Note 2) The rated electric current in the above table (current value indicated on the pump nameplate) is the recommended preset current value of the protective device.

• Models VKB-AQ-e

Model	VKB04□□2AQ-e		VKB05□□2AQ-e		VKB06□□2AQ-e		VKB07□□2AQ-e		VKB08□□2AQ-e		VKB09□□2AQ-e		VKB10□□2AQ-e		VKB11□□2AQ-e		VKB12□□2AQ-e	
Specifications																		
Nominal output (kW)	0.72	1.2	0.9	1.5	1.08	1.8	1.26	2.1	1.44	2.4	1.62	2.7	1.8	3	1.98	3.3	2.16	3.6
Rated voltage (V)	200	200 220	200	200 220	200	200 220	200	200 220	200	200 220	200	200 220	200	200 220	200	200 220	200	200 220
Frequency (Hz)	50	60	50	60	50	60	50	60	50	60	50	60	50	60	50	60	50	60
Rated electric current (A)	6.0	6.0 5.8	7.0	8.8 8.3	7.8	10.0 9.1	12.4	11.3 11.4	12.9	12.7 12.6	13.6	14.0 13.5	14.3	15.5 14.8	15.3	16.2 15.3	16.3	16.2 15.3
Starting electric current (A)	56.0	55.0 60.0	84.0	73.0 80.0	84.0	73.0 80.0	180	152 167	180	152 167	180	152 167	180	152 167	180	152 167	180	152 167
Discharge rate (L/min)	85	100	85	100	85	100	85	100	85	100	85	100	85	100	85	100	85	100
Total head (m)	26	36	33	46	39	54	45	63	52	72	58	81	65	90	71	99	78	108
Maximum allowable limit of dynamic viscosity [mm ² /s]	75	37.5	75	75	75	37.5	75	75	75	75	75	75	75	75	75	75	75	37.5

Note 1) The rated electric current in the above table (current value indicated on the pump nameplate) is the recommended preset current value of the protective device.

• Models VKB-FQ-e (50Hz dedicated models)

Model	VKB04□□2FQ-e		VKB05□□2FQ-e		VKB06□□2FQ-e		VKB07□□2FQ-e		VKB08□□2FQ-e		VKB09□□2FQ-e		VKB10□□2FQ-e		VKB13□□2FQ-e	
Specifications																
Nominal output (kW)	0.72	0.9	1.08	1.26	1.44	1.62	1.8	2.16	2.34	2.7	3.06	3.24	3.42	3.6	3.78	
Rated voltage (V)	200	200	200	200	200	200	200	200	200	200	200	200	200	200	200	
Rated electric current (A)	4.4	6.0	6.4	6.8	7.6	8.4	9.2	10.0	10.8	11.6	12.4	13.2	14.0	14.8	15.6	
Starting electric current (A)	30.0	56.0	56.0	84.0	84.0	180	180	180	180	180	180	180	180	180	180	
Discharge rate (L/min)	85	85	85	85	85	85	85	85	85	85	85	85	85	85	85	
Total head (m)	26	33	39	45	52	58	65	72	78	84	90	96	102	108	114	
Maximum allowable limit of dynamic viscosity [mm ² /s]	1	1	1	1	1	1	1	1	1	1	1	1	1	1	1	

Model	VKB14□□2FQ-e		VKB15□□2FQ-e		VKB16□□2FQ-e		VKB17□□2FQ-e		VKB18□□2FQ-e		VKB19□□2FQ-e		VKB20□□2FQ-e		VKB21□□2FQ-e	
Specifications																
Nominal output (kW)	2.52	2.7	2.88	3.06	3.24	3.42	3.6	3.78	3.96	4.14	4.32	4.5	4.68	4.86	5.04	
Rated voltage (V)	200	200	200	200	200	200	200	200	200	200	200	200	200	200	200	
Rated electric current (A)	14.2	14.8	15.6	16.3	16.9	17.4	17.4	17.4	17.4	17.4	17.4	17.4	17.4	17.4	17.4	
Starting electric current (A)	180	180	180	180	180	180	180	180	180	180	180	180	180	180	180	
Discharge rate (L/min)	85	85	85	85	85	85	85	85	85	85	85	85	85	85	85	
Total head (m)	91	97	104	110	117	123	130	136	142	148	154	160	166	172	178	
Maximum allowable limit of dynamic viscosity [mm ² /s]	1	1	1	1	1	1	1	1	1	1	1	1	1	1	1	

Note 1) The 50Hz dedicated models can be used exclusively for water-soluble coolant (dynamic viscosity: up to 1 mm²/s). If you need to pump oil-based coolant, consult us.

Note 2) The rated electric current in the above table (current value indicated on the pump nameplate) is the recommended preset current value of the protective device.

(2) Dimensions table

• Models VKB-AH-e

(Unit: mm)

(Unit: mm)

Model	Fig.	L	LH	LK	Approx. weight (kg)
VKB05102AH-e	2	632	300	258	25
VKB05112AH-e		652	320	278	25
VKB05132AH-e		692	360	318	25
VKB05152AH-e		731	399	357	26
VKB05172AH-e		770	438	396	26
VKB05182AH-e		790	458	416	26
VKB06102AH-e		632	300	258	25
VKB06112AH-e		652	320	278	25
VKB06132AH-e		692	360	318	25
VKB06152AH-e		731	399	357	26
VKB06172AH-e		770	438	396	26
VKB06182AH-e		790	458	416	26
VKB07102AH-e		632	300	258	25
VKB07112AH-e		652	320	278	25
VKB07132AH-e		692	360	318	25
VKB07152AH-e		731	399	357	26
VKB07172AH-e	770	438	396	26	
VKB07182AH-e	790	458	416	26	
VKB08102AH-e	3	657	300	258	30
VKB08112AH-e		677	320	278	30
VKB08132AH-e		717	360	318	30
VKB08152AH-e		756	399	357	31
VKB08172AH-e		795	438	396	31
VKB08182AH-e		815	458	416	31
VKB08212AH-e		874	517	475	32
VKB08222AH-e		894	537	495	32
VKB08262AH-e		973	616	574	33
VKB09102AH-e		657	300	258	30
VKB09112AH-e		677	320	278	30
VKB09132AH-e		717	360	318	30
VKB09152AH-e		756	399	357	31
VKB09172AH-e		795	438	396	31
VKB09182AH-e		815	458	416	32
VKB09212AH-e		874	517	475	32
VKB09222AH-e	894	537	495	32	
VKB09262AH-e	973	616	574	33	

Model	Fig.	L	LH	LK	Approx. weight (kg)
VKB10102AH-e	4	697	300	258	37
VKB10112AH-e		717	320	278	37
VKB10132AH-e		757	360	318	38
VKB10152AH-e		796	399	357	38
VKB10172AH-e		835	438	396	39
VKB10182AH-e		855	458	416	39
VKB10212AH-e		914	517	475	39
VKB10222AH-e		934	537	495	40
VKB10262AH-e		1013	616	574	41
VKB11112AH-e		717	320	278	37
VKB11132AH-e		757	360	318	38
VKB11152AH-e		796	399	357	38
VKB11172AH-e		835	438	396	39
VKB11182AH-e		855	458	416	39
VKB11212AH-e		914	517	475	39
VKB11222AH-e		934	537	495	40
VKB11262AH-e	1013	616	574	41	
VKB12122AH-e	737	340	298	38	
VKB12132AH-e	757	360	318	38	
VKB12152AH-e	796	399	357	38	
VKB12172AH-e	835	438	396	39	
VKB12182AH-e	855	458	416	39	
VKB12202AH-e	894	497	455	39	
VKB12222AH-e	934	537	495	40	
VKB12262AH-e	1013	616	574	41	
VKB13132AH-e	757	360	318	38	
VKB13152AH-e	796	399	357	38	
VKB13182AH-e	855	458	416	39	
VKB13202AH-e	894	497	455	39	
VKB13222AH-e	934	537	495	40	
VKB13262AH-e	1013	616	574	41	
VKB14142AH-e	776	379	337	38	
VKB14152AH-e	796	399	357	38	
VKB14182AH-e	855	458	416	39	
VKB14192AH-e	875	478	436	39	
VKB14202AH-e	894	497	455	39	
VKB14222AH-e	934	537	495	40	
VKB14262AH-e	1013	616	574	41	
VKB15152AH-e	796	399	357	38	
VKB15182AH-e	855	458	416	39	
VKB15202AH-e	894	497	455	40	
VKB15222AH-e	934	537	495	40	
VKB15262AH-e	1013	616	574	41	
VKB16162AH-e	816	419	377	39	
VKB16182AH-e	855	458	416	39	
VKB16202AH-e	894	497	455	40	
VKB16222AH-e	934	537	495	40	
VKB16262AH-e	1013	616	574	41	
VKB17172AH-e	835	438	396	39	
VKB17182AH-e	855	458	416	39	
VKB17202AH-e	894	497	455	40	
VKB17212AH-e	914	517	475	40	
VKB17222AH-e	934	537	495	40	
VKB17262AH-e	1013	616	574	41	
VKB18182AH-e	855	458	416	39	
VKB18202AH-e	894	497	455	40	
VKB18212AH-e	914	517	475	40	
VKB18222AH-e	934	537	495	40	
VKB18242AH-e	973	576	534	41	
VKB18252AH-e	993	596	554	41	
VKB18262AH-e	1013	616	574	41	
VKB19212AH-e	914	517	475	40	
VKB19262AH-e	1013	616	574	41	

• Models VKB-FH-e

(Unit: mm)						
Model	Fig.	L	LH	LK	Approx. weight (kg)	
VKB05102FH-e	1	612	300	258	21	
VKB05112FH-e		632	320	278	20	
VKB05132FH-e		672	360	318	21	
VKB05152FH-e		711	399	357	21	
VKB05182FH-e		770	458	416	22	
VKB06102FH-e		612	300	258	21	
VKB06112FH-e		632	320	278	21	
VKB06132FH-e		672	360	318	21	
VKB06152FH-e		711	399	357	21	
VKB06182FH-e		770	458	416	22	
VKB07102FH-e		612	300	258	21	
VKB07112FH-e		632	320	278	21	
VKB07132FH-e		672	360	318	21	
VKB07152FH-e		711	399	357	22	
VKB07172FH-e		750	438	396	22	
VKB07182FH-e		770	458	416	22	
VKB07222FH-e		849	537	495	23	
VKB07262FH-e		928	616	574	24	
VKB08102FH-e		2	632	300	258	25
VKB08112FH-e			652	320	278	25
VKB08132FH-e	692		360	318	25	
VKB08152FH-e	731		399	357	26	
VKB08172FH-e	770		438	396	26	
VKB08182FH-e	790		458	416	27	
VKB08212FH-e	849		517	475	27	
VKB08222FH-e	869		537	495	27	
VKB08262FH-e	948		616	574	28	
VKB09102FH-e	632		300	258	25	
VKB09112FH-e	652		320	278	25	
VKB09132FH-e	692		360	318	26	
VKB09152FH-e	731		399	357	26	
VKB09172FH-e	770		438	396	26	
VKB09182FH-e	790		458	416	27	
VKB09212FH-e	849		517	475	27	
VKB09222FH-e	869		537	495	28	
VKB09262FH-e	948		616	574	28	
VKB10102FH-e	632		300	258	25	
VKB10112FH-e	652		320	278	25	
VKB10132FH-e	692	360	318	26		
VKB10152FH-e	731	399	357	26		
VKB10172FH-e	770	438	396	26		
VKB10182FH-e	790	458	416	27		
VKB10212FH-e	849	517	475	27		
VKB10222FH-e	869	537	495	28		
VKB10262FH-e	948	616	574	28		

(Unit: mm)					
Model	Fig.	L	LH	LK	Approx. weight (kg)
VKB11112FH-e	3	677	320	278	30
VKB11132FH-e		717	360	318	31
VKB11152FH-e		756	399	357	31
VKB11172FH-e		795	438	396	31
VKB11182FH-e		815	458	416	32
VKB11212FH-e		874	517	475	32
VKB11222FH-e		894	537	495	33
VKB11262FH-e		973	616	574	33
VKB12122FH-e		697	340	298	30
VKB12132FH-e		717	360	318	31
VKB12152FH-e		756	399	357	31
VKB12172FH-e		795	438	396	32
VKB12182FH-e		815	458	416	32
VKB12212FH-e		854	497	455	32
VKB12222FH-e		894	537	495	33
VKB12262FH-e		973	616	574	34
VKB13132FH-e		717	360	318	31
VKB13152FH-e		756	399	357	31
VKB13172FH-e		795	438	396	32
VKB13182FH-e		815	458	416	32
VKB13212FH-e		854	497	455	32
VKB13222FH-e		894	537	495	33
VKB13262FH-e		973	616	574	34
VKB14142FH-e		736	379	337	31
VKB14152FH-e		756	399	357	31
VKB14182FH-e		815	458	416	32
VKB14212FH-e		854	497	455	33
VKB14222FH-e		894	537	495	33
VKB14262FH-e		973	616	574	34
VKB15152FH-e		756	399	357	31
VKB15162FH-e	776	419	377	32	
VKB15172FH-e	795	438	396	32	
VKB15182FH-e	815	458	416	32	
VKB15212FH-e	854	497	455	33	
VKB15222FH-e	894	537	495	33	
VKB15262FH-e	973	616	574	34	
VKB16162FH-e	776	419	377	32	
VKB16172FH-e	795	438	396	32	
VKB16182FH-e	815	458	416	32	
VKB16212FH-e	854	497	455	33	
VKB16222FH-e	894	537	495	33	
VKB16262FH-e	973	616	574	34	
VKB17172FH-e	795	438	396	32	
VKB17182FH-e	815	458	416	32	
VKB17212FH-e	874	517	475	33	
VKB17222FH-e	894	537	495	33	
VKB17262FH-e	973	616	574	34	
VKB18182FH-e	815	458	416	32	
VKB18212FH-e	874	517	475	33	
VKB18222FH-e	894	537	495	33	
VKB18232FH-e	933	576	534	33	
VKB18262FH-e	973	616	574	34	
VKB19192FH-e	835	478	436	33	
VKB19212FH-e	874	517	475	33	
VKB19222FH-e	894	537	495	33	
VKB19262FH-e	973	616	574	34	
VKB20202FH-e	894	497	455	40	
VKB20212FH-e	914	517	475	40	
VKB20222FH-e	934	537	495	40	
VKB20262FH-e	1013	616	574	41	
VKB21212FH-e	914	517	475	40	
VKB21222FH-e	934	537	495	41	
VKB21262FH-e	1013	616	574	41	
VKB22222FH-e	934	537	495	41	
VKB22242FH-e	973	576	534	41	
VKB22262FH-e	1013	616	574	41	
VKB23232FH-e	953	556	514	41	
VKB23262FH-e	1013	616	574	42	
VKB24242FH-e	973	576	534	41	
VKB24262FH-e	1013	616	574	42	
VKB25252FH-e	993	596	554	41	
VKB25262FH-e	1013	616	574	42	
VKB26262FH-e	1013	616	574	42	

• Models VKB-AQ-e

(Unit: mm)						
Model	Fig.	L	LH	LK	Approx. weight (kg)	
VKB04072AQ-e	2	623	291	249	24	
VKB04082AQ-e		651	319	277	24	
VKB04092AQ-e		679	347	305	24	
VKB04102AQ-e		707	375	333	25	
VKB04122AQ-e		763	431	389	25	
VKB04142AQ-e		819	487	445	26	
VKB04152AQ-e		847	515	473	26	
VKB04162AQ-e		875	543	501	26	
VKB04192AQ-e		959	627	585	27	
VKB04222AQ-e		1043	711	669	28	
VKB05072AQ-e	3	648	291	249	29	
VKB05082AQ-e		676	319	277	29	
VKB05092AQ-e		704	347	305	29	
VKB05102AQ-e		732	375	333	30	
VKB05122AQ-e		788	431	389	30	
VKB05142AQ-e		844	487	445	31	
VKB05152AQ-e		872	515	473	31	
VKB05162AQ-e		900	543	501	31	
VKB05192AQ-e		984	627	585	32	
VKB05222AQ-e		1068	711	669	33	
VKB06072AQ-e		4	648	291	249	29
VKB06082AQ-e			676	319	277	29
VKB06092AQ-e			704	347	305	30
VKB06102AQ-e			732	375	333	30
VKB06122AQ-e			788	431	389	30
VKB06142AQ-e			844	487	445	31
VKB06152AQ-e			872	515	473	31
VKB06162AQ-e			900	543	501	31
VKB06192AQ-e			984	627	585	32
VKB06222AQ-e			1068	711	669	33
VKB07072AQ-e	4		688	291	249	36
VKB07082AQ-e			716	319	277	37
VKB07092AQ-e			744	347	305	37
VKB07102AQ-e		772	375	333	37	
VKB07122AQ-e		828	431	389	37	
VKB07142AQ-e		884	487	445	38	
VKB07152AQ-e		912	515	473	38	
VKB07162AQ-e		940	543	501	38	
VKB07192AQ-e		1024	627	585	39	

(Unit: mm)					
Model	Fig.	L	LH	LK	Approx. weight (kg)
VKB07222AQ-e	4	1108	711	669	40
VKB08082AQ-e		716	319	277	37
VKB08092AQ-e		744	347	305	37
VKB08102AQ-e		772	375	333	37
VKB08122AQ-e		828	431	389	38
VKB08142AQ-e		884	487	445	38
VKB08152AQ-e		912	515	473	38
VKB08162AQ-e		940	543	501	39
VKB08192AQ-e		1024	627	585	39
VKB08222AQ-e		1108	711	669	40
VKB09092AQ-e		744	347	305	37
VKB09102AQ-e		772	375	333	37
VKB09122AQ-e		828	431	389	38
VKB09142AQ-e		884	487	445	38
VKB09152AQ-e		912	515	473	38
VKB09162AQ-e		940	543	501	39
VKB09192AQ-e		1024	627	585	39
VKB09222AQ-e		1108	711	669	40
VKB10102AQ-e		772	375	333	37
VKB10122AQ-e		828	431	389	38
VKB10142AQ-e		884	487	445	38
VKB10152AQ-e		912	515	473	39
VKB10162AQ-e		940	543	501	39
VKB10192AQ-e		1024	627	585	39
VKB10222AQ-e		1108	711	669	40
VKB11112AQ-e		800	403	361	38
VKB11122AQ-e		828	431	389	38
VKB11142AQ-e		884	487	445	38
VKB11152AQ-e		912	515	473	39
VKB11162AQ-e		940	543	501	39
VKB11192AQ-e		1024	627	585	40
VKB11222AQ-e		1108	711	669	40
VKB12122AQ-e	828	431	389	38	
VKB12142AQ-e	884	487	445	38	
VKB12152AQ-e	912	515	473	39	
VKB12162AQ-e	940	543	501	39	
VKB12192AQ-e	1024	627	585	40	
VKB12222AQ-e	1108	711	669	40	

• Models VKB-FQ-e

(Unit: mm)						
Model	Fig.	L	LH	LK	Approx. weight (kg)	
VKB04072FQ-e	1	603	291	249	20	
VKB04082FQ-e		631	319	277	20	
VKB04102FQ-e		687	375	333	20	
VKB04122FQ-e		743	431	389	21	
VKB04142FQ-e		799	487	445	21	
VKB04162FQ-e		855	543	501	22	
VKB04192FQ-e		939	627	585	23	
VKB04222FQ-e		1023	711	669	23	
VKB05072FQ-e		2	623	291	249	24
VKB05082FQ-e	651		319	277	24	
VKB05102FQ-e	707		375	333	25	
VKB05122FQ-e	763		431	389	25	
VKB05142FQ-e	819		487	445	26	
VKB05162FQ-e	875		543	501	26	
VKB05192FQ-e	959		627	585	27	
VKB05222FQ-e	1043		711	669	28	
VKB06072FQ-e	623		291	249	24	
VKB06082FQ-e	651		319	277	24	
VKB06102FQ-e	707		375	333	25	
VKB06122FQ-e	763		431	389	25	
VKB06142FQ-e	819		487	445	26	
VKB06162FQ-e	875		543	501	26	
VKB06192FQ-e	959		627	585	27	
VKB06222FQ-e	1043		711	669	28	
VKB07072FQ-e	3		648	291	249	29
VKB07082FQ-e			676	319	277	29
VKB07102FQ-e			732	375	333	30
VKB07122FQ-e			788	431	389	30
VKB07142FQ-e			844	487	445	31
VKB07162FQ-e		900	543	501	31	
VKB07192FQ-e		984	627	585	32	
VKB07222FQ-e		1068	711	669	33	
VKB08082FQ-e		676	319	277	30	
VKB08102FQ-e		732	375	333	30	
VKB08122FQ-e		788	431	389	30	
VKB08142FQ-e		844	487	445	31	
VKB08162FQ-e		900	543	501	31	
VKB08192FQ-e		984	627	585	32	
VKB08222FQ-e		1068	711	669	33	
VKB09092FQ-e		704	347	305	30	
VKB09102FQ-e		732	375	333	30	

(Unit: mm)					
Model	Fig.	L	LH	LK	Approx. weight (kg)
VKB09122FQ-e	3	788	431	389	31
VKB09142FQ-e		844	487	445	31
VKB09162FQ-e		900	543	501	32
VKB09192FQ-e		984	627	585	32
VKB09222FQ-e		1068	711	669	33
VKB10102FQ-e		732	375	333	30
VKB10122FQ-e		788	431	389	31
VKB10142FQ-e		844	487	445	31
VKB10162FQ-e		984	627	585	32
VKB10192FQ-e		1012	655	613	32
VKB10222FQ-e		1068	711	669	33
VKB13132FQ-e		4	856	459	417
VKB13142FQ-e	884		487	445	39
VKB13162FQ-e	940		543	501	39
VKB13192FQ-e	1024		627	585	40
VKB13202FQ-e	1052		655	613	40
VKB13222FQ-e	1108		711	669	41
VKB14142FQ-e	884		487	445	39
VKB14162FQ-e	940		543	501	39
VKB14192FQ-e	1024		627	585	40
VKB14222FQ-e	1108		711	669	41
VKB15152FQ-e	912		515	473	39
VKB15162FQ-e	940		543	501	39
VKB15192FQ-e	1024		627	585	40
VKB15222FQ-e	1108		711	669	41
VKB16162FQ-e	940		543	501	39
VKB16192FQ-e	1024		627	585	40
VKB16222FQ-e	1108		711	669	41
VKB17172FQ-e	968		571	529	40
VKB17192FQ-e	1024		627	585	40
VKB17222FQ-e	1108		711	669	41
VKB18182FQ-e	996		599	557	40
VKB18192FQ-e	1024	627	585	40	
VKB18222FQ-e	1108	711	669	41	
VKB19192FQ-e	1024	627	585	40	
VKB19222FQ-e	1108	711	669	41	
VKB20202FQ-e	1052	655	613	41	
VKB20222FQ-e	1108	711	669	41	
VKB21212FQ-e	1080	683	641	41	
VKB21222FQ-e	1108	711	669	41	

2.7 Internal structure drawing

● Models VKB-AH/FH-e

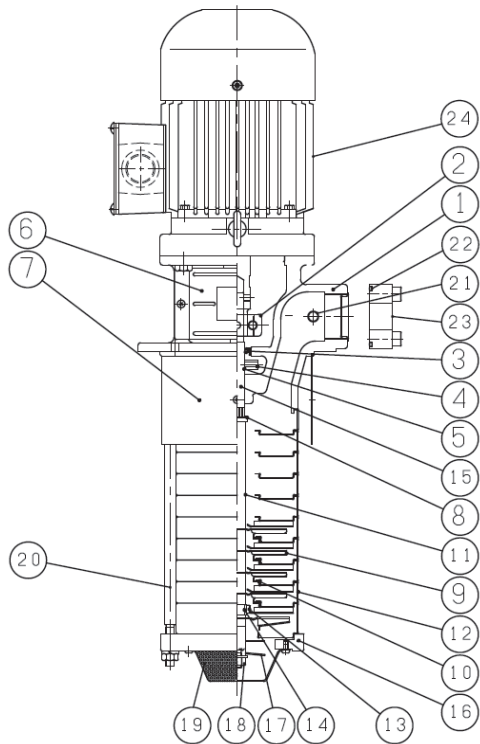

No.	Part name	Material
1	Pump leg	FC200
2	Coupling	S45C
3	Oil seal	NBR
4	Slinger	SUS304
5	O-ring	FKM
6	Coupling guard	SUS304
7	Outer cylinder	SUS304
8	Washer	SUS403
9	Impeller	SUS304
10	Seal ring	PTFE
11	Collar	SUS304
12	Casing	SUS304
13	Bearing ring	Ceramic
14	Sleeve	WC
15	Main shaft	SUS316
16	Suction chamber	FC200
17	Screw	SUS304
18	U-nut	SUS304
19	Wide strainer	SUS304
20	Tie bolt	SUS304
21	Air vent valve	Brass
22	O-ring	FKM
23	Companion flange	FC150
24	Motor	-

● Models VKB-AQ/FQ-e

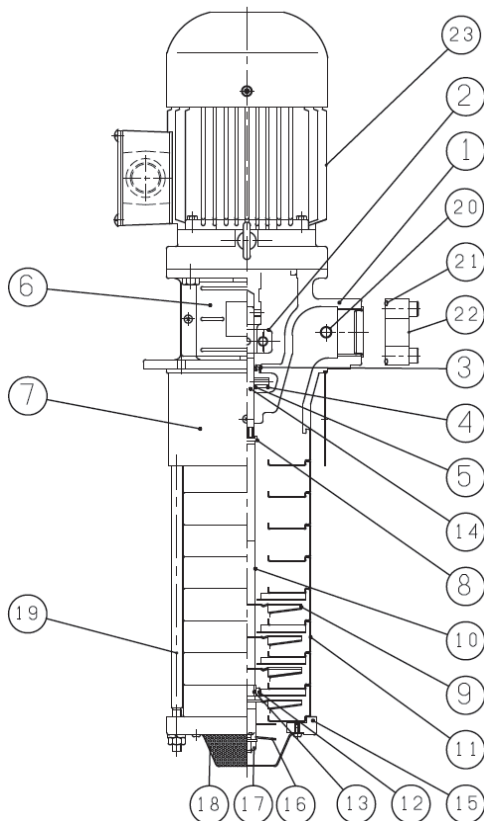

No.	Part name	Material
1	Pump leg	FC200
2	Coupling	S45C
3	Oil seal	NBR
4	Slinger	SUS304
5	O-ring	FKM
6	Coupling guard	SUS304
7	Outer cylinder	SUS304
8	Washer	SUS403
9	Impeller	SUS304
10	Collar	SUS304
11	Casing	SUS304
12	Bearing ring	Ceramic
13	Sleeve	WC
14	Main shaft	SUS316
15	Suction chamber	FC200
16	Screw	SUS304
17	U-nut	SUS304
18	Wide strainer	SUS304
19	Tie bolt	SUS304
20	Air vent valve	Brass
21	O-ring	FKM
22	Companion flange	FC150
23	Motor	-

Typical models are shown in these figures. The shapes may be slightly different depending on the model and specifications. because some of the specifications may be changed due to design changes or for other reasons, refer to the delivery specifications when planning your pumping work.

3. Transportation, conveyance, storage and installation

3.1 Precautions for transporting, moving and storing the pump

- (1) Do not unpack the container unless unnecessary.
If you unpack the container unnecessarily, securely pack again in such a manner that the product body does not jump out of it and fall down during transportation, conveyance or storage.
- (2) When you transport, move, or store the pump, ensure that the pump is located in a well-ventilated place with minimum exposure to dust and moisture in an environment at an ambient temperature of -25 to 55 degrees Celsius and humidity of less than 85%RH. The packing materials, made mainly of corrugated cardboards, break more easily when they absorb moisture.
- (3) Check the orientation of the container and then place it in the correct orientation (not upside down).
- (4) Do not stack the containers of the product more than the allowable number of units indicated on the packing material.
The maximum allowable number of stacks for this product is three.
- (5) Use extreme care so as not to give an impact or offset load to the pump during conveyance or transportation. The container may greatly incline depending on its center of gravity.



Before transporting or moving the product, confirm the weight of each unit by referring to the catalog, dimensional outline drawing, and other documents, and then determine the appropriate method.



When you lift the product by hand, pay attention to its center of gravity and weight. Do not allow a single person to lift a product heavier than 15 kg. Otherwise, it may put strain on the body, thus leading to an injury.

3.2 Before using the pump

Upon receiving the pump, check the following points first.
If you find any problems, contact the vendor from which you purchased the product.



Before unpacking the delivered container, ensure that the container is placed in the correct orientation (not upside down). Pay special attention to nails especially when opening a wooden crate. Otherwise, you may get injured.

- (1) Check the nameplate to verify that the delivered product is exactly what you ordered. (Refer to 2.4. Information indicated on the nameplates. [page 2-3].)
- (2) No part of the product is damaged during transportation.
- (3) All fastening parts including bolts and nuts are securely tightened.
- (4) All the accessories that you ordered have been delivered.







When you handle the pump, do not hold the strainer located on the tip of the pump. Otherwise, the strainer may come off, thus leading to an injury or damage.





Do not run the pump at a frequency exceeding 60 Hz (50 Hz for models dedicated to 50Hz). Otherwise, it may lead to overload and burnout of the motor.

3.3 Precautions for installation

Before rotating the main shaft by hand to check it, be sure to turn off the main power. An unexpected start of the pump may cause an accident.

Electric motor or control panel insulation degradation may result in electric leakage, electric shock, or fire.
 Keep the ambient temperature at 0 to 40°C with sufficient ventilation to prevent damage to the equipment and deterioration of its life.
 Avoid dust, corrosive or explosive gases, salinity, humidity, condensation. For indoor installations avoid direct sunlight or wind and rain.

- (1) Install the product in a well-ventilated place with minimum exposure to dust and moisture. (Refer to the Installation location in “2.3 Standard specifications [page 2-2]”). In particular, avoid installing the product in a place where the pumping liquid may be splashed on the motor section.



Do not install the product in a place exposed to high temperature and moisture. Otherwise, it may lead to heating, ignition or electric leak.

- (2) Install the product so that the motor can take air in.
- (3) Securely install the product on a flat place without any wobbles.
- (4) Select a convenient place to conduct maintenance and inspection. Secure space for maintenance.
- (5) The mounting surface must be strong enough to prevent the amplification of vibrations while the pump is running. (Restrict the total amplitudes in X, Y, and Z directions (see the right figure) to 33µm at 50 Hz and to 29µm at 60 Hz during the operation of the pump.)
- (6) It is necessary to make a mounting hole larger than the outside diameter of the pump section so that the pump section can fit into the tank (oil tank). See the dimensional outline drawing.
- (7) Install the pump so that the main shaft becomes vertical.
- (8) Use the product with the pump section immersed under the oil level. The suction port should be at least 5 mm away from the bottom surface of the tank (oil tank) to prevent the strainer from getting clogged with cutting powder, dirt, or other materials. If cutting powder, dirt, or other materials are predicted to accumulate on the bottom of the tank, ensure as large a distance as possible from the bottom at the design stage.

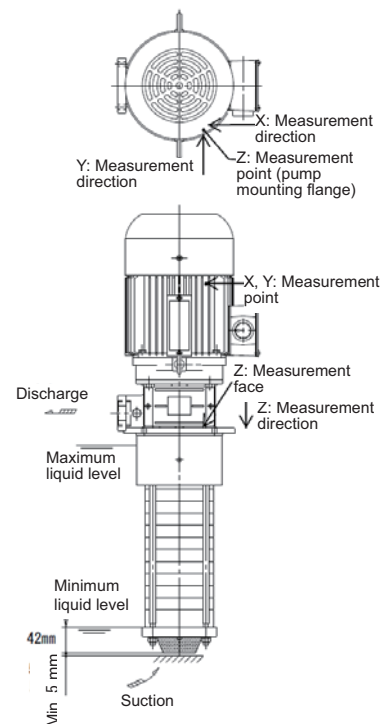

Note

Always keep the liquid level in the tank (oil tank) above the Minimum liquid level. Keep the suction port of the pump at least 5 mm away from the bottom of the tank (oil tank).



- (9) The product is coated. If you need to overcoat it in a different color for a compelling reason, lightly roughen the product surface with sand paper or the like and then coat it, which improves the adhesion properties of the coating film. (Be sure to check the overcoatability of the paint.)
- (10) Install the product at a place where a secondary hazard does not occur in the event of any liquid leak.
- (11) If the system could be exposed to the freezing temperature in winter, be sure to apply antifreeze measures such as heat insulation and heater installation to the pump, valves, piping, etc.
- (12) Securely install the pump.

Recommended size of pump mounting bolt: M6

Note

Securely fix the pump in place with the bolts. Otherwise, it may lead to abnormal vibration or other problems.

- (13) To hoist the pump, pass a rope or the like through the eyebolts of the motor. Do not hoist the equipment with the pump attached. Otherwise, it may damage the hoisting equipment/devices and the pump may fall.
- (14) When you hoist or move the pump, be sure to handle the pump carefully so that the pump section would not be subjected to an impact or imbalanced load. The container may greatly tilt depending on its center of gravity.

 **Warning** 



Before hoisting the pump, refer to the catalog, dimensional outline drawing, and other documents to check the weight of the units. Do not hoist any units if its weight exceeds the rated load of the hoisting equipment/devices.

 **Warning** 

Never use a pump that is being hoisted or install parts on it. Otherwise, the pump may fall.

 **Caution** 

When hoisting the pump, pay attention to its center of gravity. Otherwise, the pump may topple over or fall, thus leading to an injury.

 **Caution** 

When you lift the product by hand, pay attention to its center of gravity and weight. Do not allow a single person to lift a product heavier than 15 kg. Otherwise, it may put strain on the body, thus leading to an injury.

- (15) If the pumping liquid is cold, condensation may occur inside the motor while the pump is stopped. Take measures to prevent condensation, for example, by installing the pump in a sufficiently dry room or by heating and insulating the motor even when the pump is stopped.
- (16) Carry out touchup painting at a time interval suitable for the environment of use. Depending on the humidity, condensation, and other conditions, rust may form on areas such as threaded parts, worked areas, anticorrosive-coated sections.
- (17) Do not put a cover or filter over the motor. Otherwise, the temperature may increase inside the motor, thus leading to product damage, fire, or other problems.

3.4 Precautions for piping work

- (1) The pipes must be as short and straight as possible with minimal joints and valves. Use pipes whose bore size is equal to or larger than the discharge port of the pump. If the piping size is small or there are many bends, the discharge rate may become low.
- (2) Ensure to provide adequate pipe supports so that the weight of the piping system will not be applied directly to the pump body.



Do not allow the weight of the pipes to rest on the pump. Otherwise, the main shaft may be displaced from the center, thus leading to equipment damage, vibration, or noise.

- (3) Do not forcibly screw a pipe into the pump. Otherwise, it may break the joint.
- (4) Securely connect the pipes so that the connections are kept completely airtight without leakage. Prevent leaks of liquid and air with seal tape, liquid packing, or other means. Firmly wind the seal tape while paying attention not to block the piping.
- (5) Use a tank (oil tank) with as large a capacity as possible.
 - * It is recommended to use a capacity of at least three times the discharge volume per minute. Too small a capacity may cause problems such as the rise of liquid temperature, premature strainer clogging with cutting powder, and lower discharge rate caused by bubbles. When you supply a pumping liquid into a tank (oil tank), gently pour it to prevent the introduction of air.
- (6) Do not allow a large amount of cutting powder, dirt, or other contaminants from entering the pump section. Otherwise, it may clog the pump strainer, damage the pump, or significantly deteriorate the performance. Use liquids that are subjected to secondary treatment through a net cage, a chip conveyor, a magnetic separator, etc.
- (7) If water hammer may occur, attach a pressure damper (e.g. accumulator).
- (8) The pump is packaged with a companion flange for the discharge port. Use it as needed. When you use the flange, be sure to install the supplied O-ring.
- (9) If there is an upward curve on the discharge pipe, ensure that air can be vented from the section.
- (10) If you provide a relief pipe on the discharge side of the pump, also provide a sluice valve in the middle of the relief pipe to adjust the relief volume.

Note

If the amount of liquid released from the relief pipe is too much, the liquid temperature easily rises in the tank (oil tank).

- (11) On completion of the piping work, be sure to clean the tank (oil tank). Pay attention not to contaminate the system with foreign matter.

3.5 Precautions for wiring work

Danger ⚠️ ⚡

Use high-quality wiring equipment and devices, and carry out wiring work safely and securely in accordance with applicable electrical equipment technical standards and interior wiring code.
Only qualified personnel such as licensed electrical engineers are allowed to carry out electrical wiring work. Unqualified persons are prohibited by law to carry out wiring work, and it is very dangerous.

Danger ⚠️ ⚡

Securely connect the terminals of the power cable. Loose terminals may cause the motor to run in open-phase condition, thus leading to motor burnout.

- (1) For the size of the power cable and grounding wire, refer to the following:

Characteristics	Number of impellers	Minimum size of the power cable and grounding wire
-AH	5 ~ 16	1.5 mm ²
	17 ~ 19	2.5 mm ²
-FH	All number	1.5 mm ²
-AQ	4 ~ 10	1.5 mm ²
	11, 12	2.5 mm ²
-FQ	4 ~ 16	1.5 mm ²
	17 ~ 22	2.5 mm ²

Note 1) Further information is available from EN 60204-1 and IEC 60364-5-52.

Note 2) When a 3-core vinyl-insulated cable (copper conductor) is laid open to the air
(Conductor temperature: 70°C / Standard ambient temperature: 40°C)

Note 3) The wiring size may vary depending on the local wiring environment and length.
Please use the wiring of appropriate size for installation.

- (2) Be sure to install a ground fault interrupter and an overload protection device on the primary power side of the pump.

*1 Use TT or TN system for grounding.

*2 The starting current of top runner efficiency (equivalent to IE3) motor-equipped products tends to become higher than that of standard efficiency (IE1) motor-equipped products. Therefore, when you switch from an IE1 motor-equipped product, it is necessary to verify the applicability of its ground fault interrupter and overload protection device. Refer to the “Starting electric current” and “Rated electric current” specified in “2.5. Specification table [page 2-4].” If you have any questions, contact TERAL INC.

Note

When you switch from an IE1 motor-equipped product, it is necessary to verify the applicability of its protection device on the primary side of the pump.
Otherwise, the protective device may be tripped on startup.

- (3) Securely connect to the power by wiring the terminals according to the right figure (standard voltage product).

* If there are four or more terminals, follow the connection nameplate in the terminal box.

- (4) Be sure to attach a ground wire to prevent an electric shock.
Connect the ground wire to the ground terminal inside the terminal box of the motor.

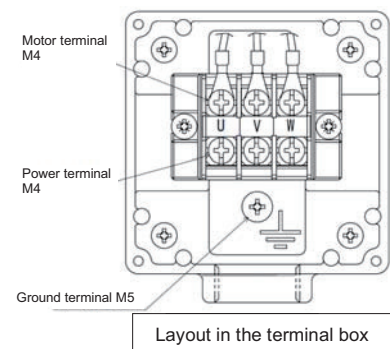



Connecting a ground wire to gas or water pipes is illegal and extremely dangerous.

- (5) To prevent the terminal block of the motor from being pulled, fasten the power cable to the terminal box with the cable lock.
- (6) To prevent overload and burnout of the motor, it is recommended to use a thermal relay for motor protection. For the recommended preset current, refer to the rated current shown in “2.5. Specification table [page 2-4].”
- (7) Carry out adequate dust-proofing and drip-proofing using a connector or gland so that cutting powder and liquid coolant do not enter the terminal box through the external wiring hole.
- (8) Pass the power cable through a metal tube or a metal conduit for shielding, and connect a ground wire to the outer surface of the tube.
- (9) Limit the fluctuations of the supply voltage within $\pm 10\%$ of the rated voltage, and also limit the fluctuations of the frequency between -5% and $+3\%$ of the rated value. Although you can run the pump in these ranges, avoid continuous operation if the voltage is not within $\pm 5\%$ of the rated value or if the frequency is not within $\pm 2\%$ of the rated value. Otherwise, it may overload the pump, thus leading to motor damage or a fire.

Even if the power fluctuations fall within the allowable ranges, the pump characteristics, motor characteristics, and the temperature rise of the motor may differ from those at the rated voltage and frequency.

- (10) Precautions for using the inverter drive
 - Ensure that the electric current during operation does not exceed 90% of the rated value.
 - Ensure that the minimum frequency is set to 10Hz.
(Contact us if you need to run the drive at 10Hz or lower.)
 - If your motor runs at a voltage other than the standard, the inverter drive cannot be used for operation. (If you need to use inverter control in such a case, contact TERAL INC.)
 - An inverter-driven motor generates a magnetic sound which may be annoying compared with the drives using commercial power supply. Although this magnetic sound does not cause an adverse effect on the quality of the motor, some inverters allow the user to adjust the tone by changing the carrier frequency. However, changing the frequency may reduce the allowable output of the inverter. Pay particular attention when selecting the inverter.
 - If the pump and motor produce resonance during normal operation, do not run them in the range of the rotation speed.





Do not run the pump at a frequency exceeding 60 Hz (50 Hz for models dedicated to 50Hz). Otherwise, it may lead to overload and burnout of the motor.

4. Operation

4.1 Check items before test operation



4.1.1 Check items related to the electrical system

- (1) Check that the equipment is correctly wired.
- (2) Check that the terminals are securely connected.
- (3) Check that the equipment is securely grounded.
- (4) Check that the setup value of the overload protection device is consistent with the rated current value of the motor.



 **Warning**  

Do not use the product at any voltage other than the rated value. Otherwise, it may lead to a fire or electric shock.

4.1.2 Check items related to the pump



 **Warning**  **Caution**  

Do not run the pump with its coupling guard or strainer removed. Otherwise, it may lead to an injury or damage.

 **Caution** 

Do not allow a large amount of foreign matter from entering the pump. Otherwise, it may damage the sliding parts (e.g. bearings) inside the pump, or lead to leakage or unusual noise.

- (1) Check that the liquid level in the tank (oil tank) is above the “Minimum liquid level.”



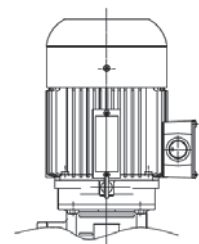
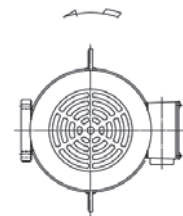

 **Caution** 

During test operation, never run the pump dry (i.e. running the pump when the liquid level is below the Minimum liquid level). During normal operation, do not run the pump dry for more than 30 seconds. Otherwise, it may seize up the sliding parts inside the pump.

Rotation direction



- (2) Check the rotation direction. Normal rotation is counterclockwise when viewed from the motor side. (See the right figure.)
- (3) Rotate the main shaft by hand to check smooth rotation. To rotate the shaft by hand, insert a flat-blade screwdriver through the fan cover of the motor and turn its shaft. If the rotation is stiff or not uniform, there may be some rust or foreign matter inside the pump. Inspect the pump in such a case.



 **Warning**   

Before rotating the main shaft by hand to check it, be sure to turn off the main power. An unexpected start of the pump may cause an accident.

- (4) Open the air vent valve to release air. After the air release, close the air vent valve. If no air vent valve is provided, open the valve on the discharge piping to release air.



(5) If you run the motor at variable speed with the inverter, be sure to check the following points through test operations.

- The pump may produce resonance depending on installation conditions. If the pump produces resonance, avoid that frequency.
- If the operation frequency is low or the dynamic viscosity of the pumping liquid is high, the pump may not discharge any liquid.
- Do not run the pump at a frequency exceeding 60 Hz (50 Hz for models dedicated to 50Hz). Otherwise, the motor may burn out.



 **Caution** 

Do not run the pump at a frequency exceeding 60 Hz (50 Hz for models dedicated to 50Hz). Otherwise, it may lead to overload and burnout of the motor.



4.2 Running the pump (test operation)

 **Warning**  





Be sure to attach the cover of the terminal box of the motor. Otherwise, it may lead to an electric shock.

 **Warning**  





Be sure to keep the coupling guard attached during the operation of the pump. Otherwise, it may lead to an injury.

 **Warning** 

Do not operate the pump if any abnormal condition is observed or if there is anything wrong with the parts, components, and others during the check before test operation. Otherwise, it may lead to an injury, failure, accident, or other problems.



 **Warning**   

If you pump a liquid above 40°C, do not touch the pump. Otherwise, its hot surface may cause burns.

 **Warning**   

Do not touch the motor during operation or immediately after the stop of operation. Otherwise, its hot surface may cause burns.

- (1) Check the rotation direction of the pump by turning on and off the power switch once or twice. Normal rotation is counterclockwise when viewed from the motor side. If the pump rotates in reverse, swap two of the three wires of the power cable.

 **Caution** 

Do not check the rotation direction by running the pump dry even for a short time. Otherwise, it may damage the sliding parts (e.g. bearings) in the pump, or lead to leakage or unusual noise.



Do not run the motor in reverse because it may cause a failure.



Do not run the pump dry, and do not allow a large amount of air or foreign matter from entering the pump. Otherwise, it may damage the sliding parts (e.g. bearings) in the pump, make it impossible to pump up liquid, or lead to leakage or unusual noise. It may also heat the pump, thus leading to burns. After installing the pump, release air through the air vent valve, and then supply the pump with the liquid up to a level above the Minimum liquid level of the pump.

- (2) If your pump is provided with an air vent valve, slightly open the valve upon startup, and confirm that liquid is discharged. Once you have confirmed the discharge, ensure to close the air vent valve.
- (3) Turn on the power to start the pump.
- (4) During the initial period of pump operation and circulation, gradually open the sluice valve on the discharge side to circulate liquid at a flow rate (flow velocity) higher than the normal operation.
- (5) Adjust the sluice valve on the discharge side so that the specified pressure is achieved. Although running the pump with the sluice valve shut does not cause the overload of the motor, long hours of continuous operation in the condition increase the liquid temperature in the pump. Therefore, allow a small amount of liquid to flow (at least 10L/min); or if you no longer use the liquid, stop the pump. Too hot liquid may reduce the service life of the motor or damage the shaft seal.
- (6) because this pump is structured without any mechanical seal (no sealing device at the shaft seal), some liquid is discharged from the outer cylinder of the pump, but it is not a product defect.
- (7) When the liquid level is too low, the pump may take air in and decrease the discharge rate, thus making it impossible to pump the liquid. Keep the liquid level above the Minimum liquid level indicated in the Dimensional outline drawing. Note that, however, this liquid level changes depending on the viscosity and liquid surface condition. For safety, set the liquid level high enough, but at a level below the "Maximum liquid level" indicated in the outline drawing.
- (8) As a guide, limit the frequency of the startups and shutdowns to about 60 times or less per hour.



Minimize the frequency of startups and shutdowns of the pump because their high frequency may quickly damage the pump. Do not start the pump more than 60 times an hour.

- (9) In the event of a power failure during operation, be sure to turn off the power.



In the event of a power failure, be sure to turn off the power switch. Otherwise, the pump may suddenly start up on restoration of the power, thus leading to an injury.

- (10) Before restarting the pump, confirm that the pump has stopped completely.



Before restarting the pump, be sure to check that the pump has stopped completely. Turning on the power while the pump is still rotating causes an excessive torque on the pump and may cause a failure.

- (11) Avoid sudden pressure fluctuations during the operation of the pump.
- (12) Check for any abnormal pressure, electric current, vibration, noise, and other conditions. If you find any abnormal conditions, take appropriate actions after consulting the Section “6. Troubleshooting (page 6-1).”

Refer to the following chart for vibration vs. rotation speed.

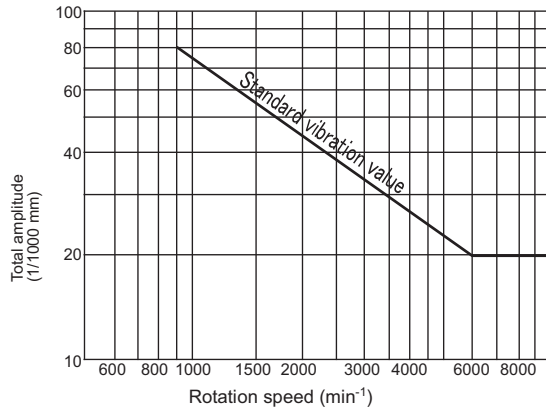

Standard vibration value at the bearing section

[For reference only]

Relation between the total amplitude (a) and the vibration velocity (V)

$$a = \frac{V \times 6 \times 10^4}{\pi \times n}$$

a: Total amplitude (μm)
 V: Vibration velocity (mm/s)
 n: Equipment rotation speed (min⁻¹)

- (13) Do not allow a large amount of cutting powder from entering the pump. Otherwise, it may clog the pump strainer, damage the pump, or significantly deteriorate the performance. If you use the pump in processes such as grinding, milling, or end milling in which a large amount of cutting powder is discharged, select the pump carefully.
- (14) Stop the pump.



Keep the cocks of the pressure gauges, compound pressure gauges, and other parts closed all the time except when they are used for measurement. Otherwise, they are more prone to fail.







Do not run the pump using the power beyond the allowable current value. Otherwise, the motor may burn out. For the allowable current value, see the characteristic curve.





Do not put your fingers or other objects into the opening of the motor. Otherwise, it may lead to an electrical shock or injury.

5. Maintenance and inspection

 **Warning**   

Before checking the pump, be sure to turn off the main power. Otherwise, the pump may suddenly start up in automatic mode or on other occasions, thus leading to great danger.

 **Warning** 

Before starting the unit or carrying out maintenance/inspection work, ensure that all the relevant workers are informed of the operation and that there are no workers in the dangerous zone.

 **Caution**

For overhaul, replacement of parts, or repairs, ask TERAL INC. Incorrect work may cause a failure or accident.

5.1 Precautions for maintenance and inspection

 **Warning** 

Regularly inspect your equipment and perform maintenance on each component.

(1) Observe the following points, in particular, during daily inspection.

- ① A large deviation in the pump's discharge pressure, electric current, vibration, noise, or other conditions from the normal status is a sign of a failure. Therefore, immediately take measures, referring to the Maintenance checklist in Section "5.3. Periodic inspection [page 5-3]." For this purpose, it is recommended to keep an operation log.
- ② If the bearing temperature gets abnormally high, immediately stop the pump and check the bearing. The temperature is normal if the temperature difference between the motor surface and the atmosphere does not exceed 40°C.
- ③ because prelubricated shielded bearings are used, there is hardly any need for maintenance of the bearings such as refilling of grease. Replace the bearings if they generate unusual noise or vibration.

Model	Bearing type	
	Load side	Non-load side
VKB05□□2FH-e~VKB07□□2FH-e, VKB04□□2FQ-e	6305 ZZ C3	6203 ZZ C3
VKB05□□AH-e~VKB09□□2AH-e, VKB08□□2FH-e~VKB19□□2FH-e VKB04□□2AQ-e~VKB06□□2AQ-e, VKB05□□2FQ-e~VKB10□□2FQ-e	6307 ZZ C3	6303 ZZ C3
VKB10□□2AH-e~VKB19□□2AH-e, VKB20□□2FH-e~VKB26□□2FH-e VKB07□□2AQ-e~VKB12□□2AQ-e, VKB13□□2FQ-e~VKB22□□2FQ-e	6309 ZZ C3	6205 ZZ C3





* Long-life urea grease is used as lubricating grease in bearings. Use bearings into which urea grease is filled. When you replace the parts, it is recommended to use a grease equivalent to the following:

- Bearings by NSK (EA2 grease), Bearings by NACHI (FNS3D grease)

- ④ An oil seal is attached to the bearing section to prevent the entry of liquid. When you replace a bearing, also replace its oil seal with a new one.

Model	Oil seal type		
	Pump section	Load side	Non-load side
VKB05□□2AH-e~VKB09□□2AH-e, VKB05□□2FH-e~VKB19□□2FH-e VKB04□□2AQ-e~VKB06□□2AQ-e, VKB04□□2FQ-e~VKB10□□2FQ-e	IS12257	DS17355	VC24406
VKB10□□2AH-e~VKB19□□2AH-e, VKB20□□2FH-e~VKB26□□2FH-e VKB07□□2AQ-e~VKB12□□2AQ-e, VKB13□□2FQ-e~VKB22□□2FQ-e		VC25455	VC24406

- ⑤ If an oil seal or V-ring is used, high-frequency sound (rubber squeak) may occasionally be generated, but it is not a pump failure. You can continue to use the pump with the same good quality.
- ⑥ Keep the cocks of the pressure gauges and compound gauge closed all the time except when inspection is required.
- ⑦ In the event of a power failure, be sure to turn off the power. The pump suddenly starts on restoration of the power, thus leading to danger.

Warning



In the event of a power failure, be sure to turn off the power switch. Otherwise, the pump may suddenly start up on restoration of the power, thus leading to an injury.

- (2) If you do not use the pump for a long time, observe the following points:

Caution

If you do not use the pump for a long time, turn off the power for safety. Otherwise, accumulated dust may cause heating or ignition.



- ① To prevent possible freezing inside the pump in winter, be sure to take antifreeze measures—such as heat insulation or the installation of a heater to the pump—or completely drain the pump.
- ② If you have a backup pump, run it from time to time to make it available for operation at any time.

5.2 Daily inspection

Upon startup and during operation, check the pump for any abnormal conditions in terms of its discharge pressure, electric current, vibration, noise, and others.

5.3 Periodic inspection

- (1) Clean any dirt, oil, and other deposits off the outer surface of the coolant pump.
- (2) Cutting powder deposited in the tank (oil tank) may cause a pump failure. Periodically clean the tank (oil tank).
- (3) Check the strainer of the pump for any clogging. Clean it if it is clogged.

Caution

Periodically clean the strainer located on the pump suction side. A clogged strainer may cause pressure fluctuations, a lower discharge rate, unusual noise, and other problems, thus leading to a pump failure.

- (4) For other inspection items, refer to the Maintenance checklist on the next page.



Maintenance checklist

Item	Inspection point	Inspection item	Inspection method	Criterion (Reference page)	Inspection interval				Timing of replacing consumables (as a guide)*1	
					Daily	Monthly	Half-yearly	Yearly		
Ambient conditions	Temperature	Check against the specified range.	Measure	Between -20 and 40°C (2-2)	✓				-	
	Humidity		Measure	Less than 85% RH (2-2)	✓				-	
	Dust and other contaminants		Visual check	No dust or other contaminants	✓				-	
Power	Power terminal block	Voltage	Measure	Specified voltage (2-2)			✓		-	
		Voltage fluctuation	Measure	Within the allowable fluctuation range (2-2)			✓		-	
		Loose screws	Tighten	Securely tightened				✓	-	
Pump and motor	Impeller	Clogging	Disassemble and inspect	No clogging				✓	-	
		Wear	Disassemble and inspect	No abnormal condition				✓	When worn out	
	Main shaft and its surrounding area	Smooth rotation	Rotate by hand	Rotation is smooth and uniform (4-1)				✓	-	
	Bearing (motor) *2	Heat	Touch	Not unusually hot (5-1)				✓	1 to 2 years	
	Submerged bearing (bearing ring and sleeve)	-	-	-	No abnormal condition				✓	1 to 2 years
	Rubber parts	O-rings	-	-	-				✓	Whenever disassembled
		Oil seals, etc.	-	-	-	No abnormal condition				✓
	Others (screws etc.)	-	-	-	No abnormal condition					As needed
	Appearance	Unusual noise, vibration	Listen Visual check	No abnormal condition	✓					-
Insulation resistance	Between the ground and each lead wire	Megger tester	1 MΩ or more					✓	-	

*1 The timing of replacing consumables (as a guide) does not mean their guaranteed service life. The service life of parts varies depending on the ambient conditions and the conditions for use.

*2 Long-life urea grease is used as lubricating grease in bearings. When you replace the parts, it is recommended to use a grease equivalent to the following:

- Bearings by NSK (EA2 grease)
- Bearings by NACHI (FNS3D grease)

Warning

If motors or control panels are used for more than a certain period of time, it may cause ignition or other accidents due to aging deterioration.

6. Troubleshooting

The following table lists causes of failures and their actions. In the event of a failure, however, you should carefully investigate the problem and ask TERAL INC. to carry out any actions that are not easy to take.

Problem	Cause (Reference page)	Action (Reference page)
The pump does not start.	Wiring is disconnected or broken. (3-4)	Check the wires and connections. Repair or replace.
	The power fuse is blown.	Replace it with an appropriate fuse.
	Tripping of the thermal relay	Check the thermal relay.
	Poor connection or contact of power wires (3-4)	Check the wires and connections.
	The power voltage is too low. (2-2)	Check the power voltage. Contact the power company.
	The motor has failed. (e.g. broken wire of the stator winding)	Repair at vendor's shop. Contact TERAL INC. because disassembly and inspection are required.
	Foreign matter is caught in the impeller.	Disassemble, clean, and repair. Contact TERAL INC. because disassembly and inspection are required.
	The bearing is rusty. (5-1)	Replace the bearing. (5-1) Contact TERAL INC. because disassembly and inspection are required.
Overload and overcurrent of the motor	The rotation speed is too high.	Check with the tachometer.
	The voltage is too high or too low.	Check the power voltage.
	Fluctuation of the voltage	Contact the power company.
	A 50Hz pump is run in the 60Hz power zone.	Check the nameplate. (2-3)
	The stator winding is broken, shorted, or grounded.	Contact TERAL INC. because disassembly and inspection are required.
	The stator and rotor are in contact due to wear of the bearing. (5-1)	Replace the bearing. (5-1) Contact TERAL INC. because disassembly and inspection are required.
	The motor is running in open-phase condition.	Check the wiring.
	The dynamic viscosity of the pumping liquid is too high. (2-2)	Use a liquid with low dynamic viscosity.
	The discharge rate is high.	Throttle the sluice valve to adjust the rate as per the specifications.
	A rotating part is in contact with another part.	Contact TERAL INC. because disassembly and inspection are required.
The pump starts, but cannot achieve the specified discharge rate and the specified head.	The pumping liquid contains many bubbles.	Prevent the formation and suction of bubbles.
	The rotation direction is reverse. (4-2)	Correct the wiring so that the motor rotates in normal direction. (4-2)
	The piping loss is high.	Check the diameter, route and length of the pipes.
	The piping is clogged with foreign matter.	Check and clean the piping.
	The impeller is worn.	Replace the impeller. Contact TERAL INC. because disassembly and inspection are required.
	Foreign matter is accumulated in the impeller and in the casing.	Remove the foreign matter, and check the connections. Contact TERAL INC. because disassembly and inspection are required.
	The rotation speed is low.	Check with the tachometer.
	The sluice valve is closed.	Open the sluice valve.

Problem	Cause (Reference page)	Action (Reference page)
The pump starts, but cannot achieve the specified discharge rate and the specified head.	The piping is clogged with foreign matter.	Check and clean the piping.
	The strainer on the suction port is clogged.	Check and clean the strainer.
	The suction port is exposed above the liquid level. (3-2)	Adjust the liquid level, for example, by refilling the tank with the liquid or by lowering the installation position of the pump.
	There is a leak in the discharge pipe.	Check and repair the pipe.
Overheat of bearing	The bearing is worn or damaged. (5-1)	Replace the bearing. (5-1) Contact TERAL INC. because disassembly and inspection are required.
	The grease is deteriorated. (5-1)	
	Incorrect installation of the pump and the piping (3-2)	Check and correctly install them.
Unusual noise and unusual vibration of the pump	The bearing is worn or damaged. (5-1)	Replace the bearing. (5-1) Contact TERAL INC. because disassembly and inspection are required.
	The motor is running in open-phase condition.	Check the wiring.
	The impeller is clogged with foreign matter, thus leading to imbalanced load.	Disassemble and check. Contact TERAL INC. because disassembly and inspection are required.
	Cavitation has occurred.	Contact TERAL INC.
	Incorrect installation of the pump and the piping (3-2)	Check and correctly install them.
Water hammer occurs.	Hammering has occurred when the valve is rapidly opened and closed.	Provide a pressure damper (e.g. accumulator).

7. After-sales service



For overhaul, replacement of parts, or repairs, ask TERAL INC.
Improper work may lead to malfunctions or accidents.





- For maintenance and repairs of the pump, ask TERAL INC.
- If you find anything unusual about the active pump, immediately stop the pump and then check the problem. (Refer to Section “6. Troubleshooting” [page 6-1].) For disassembly, inspection, or repair, ask TERAL INC. (Refer to the end of this document.)
- Never repair the pump by yourself because it may lead to danger.
- When you contact TERAL INC., inform them of the information indicated on the pump nameplate (e.g. pump model and serial number) in addition to the status of the problem.
- For the warranty, refer to “Limited warranties (page I)” on the opening page of this document.

If you have anything unclear about the product, contact TERAL INC.

8. Disposal

8.1 Precautions for disposal

Before detaching the pump from the system for disposal or replacement, be sure to turn off the main power.

 **Warning**   

Before detaching the pump, be sure to turn off the main power. Otherwise, the pump may suddenly start up in automatic mode or on other occasions, thus leading to great danger.

 **Caution** 

When hoisting the pump, pay attention to its center of gravity. Otherwise, the pump may topple over or fall, thus leading to an injury.

- (1) Drain liquid from the tank (oil tank) so that the bottom of the pump is exposed above the liquid level.
- (2) Close the sluice valve on the discharge side and open the air vent valve of the pump to discharge liquid from the pump.
- (3) Disconnect the wiring and piping. (For the layout in the terminal box, refer to “Section 3.5. Precautions for wiring work [page 3-5].”)
- (4) Remove the pump mounting bolts, pass a rope or the like through the eyebolts of the motor, and then hoist the pump. (Refer to “Section 3.3. Precautions for installation [page 3-2].”) because the liquid remaining in the pump may flow out while the pump is detached or moved, take measures against it as needed.

 **Caution** 

When you handle the pump, do not hold the strainer located on the tip of the pump. Otherwise, the strainer may come off, thus leading to an injury or damage.

- (5) Dispose of the pump as industrial waste. Dispose of other parts according to your national and local laws and regulations, for example, by asking the specialized waste disposal contractor.

Note

Dispose of the pump as industrial waste.

Note

For the packing materials that are no longer necessary after installation as well as for used lubricating oils and parts that are no longer necessary after maintenance, inspection, repairs, and replacement, dispose of them according to your national and local laws and regulations, for example, by asking the specialized waste disposal contractor.

TERAL
TERAL INC.

Head Office

230, Moriwake, Miyuki-cho, Fukuyama-city, Hiroshima, 720-0003, Japan
Tel.+81-84-955-1111 Fax.+81-84-955-5777

www.teral.net